

## Operating Instructions L-BL2N

2BL2041 | 2BL2061 | 2BL2101 | 2BL2141 |  
2BL2251 | 2BL2281 | 2BL2341



**L-Serie  
L-Series**

Flüssig-  
keitsring  
*Liquid Ring*



<b>1</b>	<b>About this manual .....</b>	<b>4</b>
1.1	Content of this document .....	4
1.2	Target group .....	4
1.3	Explanation of the terms and symbols .....	4
1.4	Changes in comparison to the previous version .....	6
1.5	Other valid documents .....	6
<b>2</b>	<b>Safety and responsibility .....</b>	<b>7</b>
2.1	Explanation of warning signs .....	7
2.2	Correct use of the equipment .....	7
2.3	Unauthorised operation .....	7
2.4	Working in a safety-conscious manner .....	8
2.5	Requirements for personnel .....	9
2.5.1	Personnel qualifications and training .....	9
2.5.2	Personal protective equipment .....	10
2.6	Requirements of the operator .....	11
<b>3</b>	<b>Product identification .....</b>	<b>12</b>
3.1	Structure of the type description .....	12
3.2	Rating plate .....	13
3.3	Design of the machine .....	14
3.4	Function principle .....	16
3.5	EC/EU declaration of conformity .....	17
<b>4</b>	<b>Transportation and storage .....</b>	<b>18</b>
4.1	Unpacking and checking the condition of delivery .....	18
4.2	Lifting and transporting .....	18
4.3	Storage .....	19
<b>5</b>	<b>Installation .....</b>	<b>20</b>
5.1	Measures after long-term storage .....	20
5.2	Mounting conditions .....	20
5.3	Reduction of oscillations and noises .....	20
5.4	Level assembly on the foot .....	21
5.5	Mount the accessories .....	21
5.6	Connecting pipelines and hoses .....	21
<b>6</b>	<b>Electric power connection .....</b>	<b>23</b>
6.1	General installation regulations .....	23
6.2	Controls .....	24
6.3	Connect the motor to the mains .....	25
6.4	Connecting accessories .....	26
<b>7</b>	<b>Commissioning .....</b>	<b>27</b>
7.1	Measures after a long shut-down period .....	27
7.2	Initial filling with operating liquid .....	27
7.3	Tests during commissioning or re-commissioning .....	28
7.4	Check the direction of rotation .....	28
7.5	Sensors function check .....	28
7.6	Measure oscillations .....	28
<b>8</b>	<b>Operation .....</b>	<b>29</b>
8.1	Switch on .....	29
8.2	Use in the working process .....	29
8.2.1	Loss of operating fluid .....	29
8.2.2	Increase in operating fluid .....	30
8.3	Switch off .....	30
8.4	Switch off in emergency .....	30
<b>9</b>	<b>Troubleshooting .....</b>	<b>31</b>

<b>10</b>	<b>Maintenance</b> .....	<b>33</b>
10.1	Maintenance .....	33
10.2	Repairs and complaints .....	34
10.3	Ordering spare parts .....	34
<b>11</b>	<b>Decommissioning</b> .....	<b>35</b>
11.1	Decommissioning .....	35
11.1.1	Draining down .....	35
11.1.2	Corrosion inhibitor for storage .....	35
11.2	Disassembly .....	36
11.3	Disposal .....	36
<b>12</b>	<b>Technical data</b> .....	<b>37</b>
12.1	Permitted conditions for use .....	37
12.1.1	Installation height .....	37
12.1.2	Rotational speeds .....	37
12.1.3	Temperatures .....	37
12.1.4	Vacuum operation pressures .....	37
12.1.5	Relative humidity .....	37
12.1.6	Minimum distances for heat dissipation .....	38
12.1.7	Speed of oscillation .....	38
12.1.8	Accelerations .....	38
12.2	Electrical data .....	38
12.2.1	Increased operating cycle frequency .....	38
12.3	Filling quantities .....	38
12.3.1	Quantity of operating fluid for first fill .....	38
12.3.2	Filling quantity of descaling agent .....	39
12.3.3	Filling quantity of corrosion inhibitor .....	39
12.4	Weight .....	39
12.5	Acoustic emissions .....	39

## 1.1 Content of this document

These operating instructions:

- Is a component of the circulation vacuum pump:

Series	L-BL2N	
Types	2BL2041	2BL2061
	2BL2101	2BL2141
	2BL2251	2BL2281
	2BL2341	

- describe the safe, proper and efficient use in all phases of its service life.
- must always be available to personnel at the place of use.
- Arranged in the main sections:
  - About these instructions
  - Safety and responsibility
  - Product identification
  - Transportation and storage
  - Mounting
  - Electric power connection
  - Commissioning
  - Operation
  - Troubleshooting
  - Maintenance, repairs and spare parts
  - Decommissioning
  - Technical data





The main section on “Safety and responsibility” must always be observed. The subsequent main sections can be used as a reference and can be read independently from each other. Cross references provided must be observed.



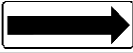

## 1.2 Target group

These instructions are intended for operating personnel, qualified personnel, electricians, operators and planners. See also Personnel qualifications and training [→ 9].

## 1.3 Explanation of the terms and symbols

In these instructions symbols and terms will be used to mean the following.

Symbol	Explanation
!	Requirement, pre-requisite
①	One-step handling instructions
1 2 3	Multi-step handling instructions
✓	Result
[→ 54]	Cross reference with page reference
	Additional information, tips
	Direction of rotation arrow
	Direction of conveyance arrow
	General warning sign (warning of risk of injury)
	L-BL2N can start without warning

Symbol	Explanation
	Electrical voltage warning
	Hot surface warning
	Disconnect prior to maintenance or repair
	Earth prior to use
	Observe the instructions

Term	Explanation
Plant	Part provided by the user in which the L-BL2N is installed
L-BL2N = Circulation vacuum pump	Ready-to-connect liquid-ring vacuum pump built into a separator as well as other accessories, where applicable, used to generate a vacuum. The liquid-ring vacuum pump consists of a compressor and a drive.
Drive	Asynchronous motor
Liquid ring	Compression principle
Pump part	Mechanical part of the liquid-ring vacuum pump without a drive
Inside of the pump	Chamber of the liquid-ring vacuum pump used to convey material
Impeller	Rotating component for generating pressure within the inner chamber of the compressor
Gas inlet	Position for gas inlet
Gas outlet	Position for gas outlet
Substructure	Mounting plate, base frame or foundation on which the L-BL2N is constructed
Elastic / rigid	When the lowest normal frequency of the system, consisting of the L-BL2N and substructure, is less than 25% above the rotary frequency of the L-BL2N per measurement direction, then the substructure is considered to be rigid. All other substructures are considered to be elastic.
Assembly environment	Space in which the L-BL2N is set up and operated (this may differ from the suction environment)
Suction/discharge environment	Chamber from which the media to be conveyed is suctioned or in which the media to be conveyed is expelled (this may differ from the assembly environment)
Reference conditions	<ul style="list-style-type: none"> <li>▪ Ambient temperature and suction temperature: <b>+20°C</b> (+68°F)</li> <li>▪ Ambient pressure: <b>1013 mbar abs.</b> (14.7 psi abs.)</li> <li>▪ Conveyed media: Air with <b>+20°C</b> (+68°F) and 50% relative humidity</li> <li>▪ Speed 2BL2041–2BL2141: 3000 min<sup>-1</sup> (50Hz) and 3600 min<sup>-1</sup> (60 Hz) in continuous operation</li> <li>▪ Speed 2BL2251–2BL2341: 1500 min<sup>-1</sup> (50Hz) and 1800 min<sup>-1</sup> (60 Hz) in continuous operation</li> <li>▪ operating fluid: Water with <b>+15°C</b> (+59°F) and rated operating fluid flow</li> <li>▪ Horizontal assembly</li> </ul>
Rated operating fluid flow	Required amount of operating fluid to achieve the characteristic curve under the reference conditions
Volume flow	Volume of air or gas that is conveyed per unit of time

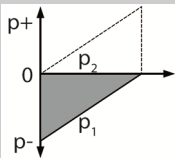
Term	Explanation
Vacuum operation	Operation with - pressure at gas inlet $p_1 < p_{\text{atm}}$ . and - pressure at gas outlet $p_2 = p_{\text{atm}}$ . 
Mobile operation	Non-stationary operation
Anti-clockwise operation (standard)	The direction of rotation is anti-clockwise when facing the pump cover
Cavitation	emergence and sudden collapse (implosion) of vapour bubbles in the rotating operating fluid. During the implosion, noise and extreme pressures occur on very small surfaces. These forces can destroy the pump over a long period of time due to surface erosion.
Cavitation area	Pressure range in which cavitation occurs if no cavitation protection measures are taken

## 1.4 Changes in comparison to the previous version

Changes compared with version 10-A1.2017

- Weight [→ 39]

## 1.5 Other valid documents

In addition to these instructions consider the following documents:

Document	Purpose
Data sheet	Technical data of the L-BL2N
Spare parts list	List of spare parts
Assembly instructions *	Description of the assembly of the manufacturer's accessories
Supplier documentation *	Operating manual and further documentation of the supplier's components

\*according to the model option or accessories

The manufacturer is not liable for damage caused by the failure to observe these instructions and the related documents [→ 6].

## 2.1 Explanation of warning signs

Warning sign	Explanation
⚠ <b>DANGER</b>	Danger that failure to observe the measures could lead to death or serious physical injuries.
⚠ <b>WARNING</b>	Danger that failure to observe the measures could lead to death or serious physical injuries.
⚠ <b>CAUTION</b>	Danger that failure to observe the measures could lead to minor physical injuries.
<b>NOTICE</b>	Danger that failure to observe the measures could lead to material damage.

## 2.2 Correct use of the equipment

- should only be used within the limits defined in this documentation:
  - Mounting conditions [→ 20]
  - Permitted conditions for use [→ 37]
  - Electrical data [→ 38]
- only operate when fully assembled and in a technically perfect condition.
- Can suction the following conveyed media:
  - Air or air-vapour mixtures
  - all non-explosive, non-combustible, non-abrasive and non-toxic gasses and gas/air mixtures, after consultation with the manufacturer
- is designed to operate with the following operating fluid:
  - Water with a pH-value of 6 to 9 and free of solid matter (e.g. sand)

Other operating conditions must be agreed with the manufacturer.

## 2.3 Unauthorised operation

It is forbidden to:

- Operating in a potentially explosive area (ATEX).
- Connecting to a potentially explosive area (ATEX).
- Transporting explosive, flammable, aggressive, unstable, oxydative or poisonous materials.
- Using non-commercial facilities without making adjustments for the additional requirements.
- Operating in reverse with sudden/abrupt changes in the direction of rotation.  
**NOTICE! This results in high drive loads and alternating stresses. The machine can be destroyed.**
- Use in areas with ultrasound and ionising or non-ionising radiation.
- Operating outside of the limits defined in this document:
  - Mounting conditions [→ 20]
  - Permitted conditions for use [→ 37]
  - Electrical data [→ 38]

### 2.4 Working in a safety-conscious manner

**Work at a standstill and de-energised** **Work on running or energised vacuum pumps/compressors can lead to serious injuries due to body parts being drawn in or crushed or death due to electric shock.**



- ① Work on the L-BL2N at a standstill only and in a de-energized condition.

**Negative/overpressure and ejected media** **Pressures and ejected media can cause serious injuries.**

1. Depressurise the system before starting work on the L-BL2N.
2. Check that all components are depressurised.
3. Check that no media can escape.

**Screw connections** **Screws can damage the thread when screwed in repeatedly. This can cause screwed parts to become loose and lead to severe injuries.**

1. Replace damaged screws.
2. Insert screws into the open thread by hand.
3. Afterwards, use a screwdriver to tighten the screws.

**Hot surfaces** **After decommissioning, contact with hot surfaces in the interior can lead to burns.**



- ① Allow the L-BL2N to cool after shutting it down.

**Not fully assembled or damaged** **Operation with exposed or damaged parts can lead to serious injuries due to body parts being drawn in and severed or crushed.**

1. Replace damaged parts prior to beginning operation.
2. Re-attach safety and protective devices and put them back into operation immediately after completion of work.
3. The L-BL2N should only be put into operation when fully assembled.

**Changes, additions and conversions** **Changes, additions and conversions may lead to unforeseeable risks and thus to serious injuries or death.**

Modifications, additions and conversions not described in the general documentation are the sole responsibility of the operator.

Only use original parts or parts and auxiliary materials (grease, sealant) recommended by the manufacturer.

Keep all notices attached to the L-BL2N in a clearly legible condition:

- Labelling of connections
- rotation arrows
- Rating plate
- Warning signs



## 2.5 Requirements for personnel

### 2.5.1 Personnel qualifications and training



#### *NOTICE*

**Voiding of the warranty!**

**Repairs carried out by untrained and unauthorised repair personnel during the warranty period can result in the voiding of the warranty.**

- ① Repairs during the warranty period should be carried out only by trained and authorised personnel.



All those who will work on the L-BL2N must have read and understood these instructions and the related documents [→ 6].

Personnel in training may only work on the L-BL2N under supervision of personnel who have the **required knowledge**.

Only personnel with the following knowledge may carry out the work described in these instructions:

Work task	Personnel	Required knowledge
Transportation, storage	Shipper, dealer, fitter	<ul style="list-style-type: none"> <li>▪ Safe handling with lifting gear such as hoists and fork lift trucks</li> </ul>
Assembly, start-up, correcting faults, shut down, dismantling	Fitter	<ul style="list-style-type: none"> <li>▪ Safe handling of tools</li> <li>▪ Laying and connecting pipes and hoses</li> <li>▪ Mounting mechanical components</li> <li>▪ Knowledge of vacuum pumps and compressors</li> </ul>
Working on the electrical system	Electrician	<ul style="list-style-type: none"> <li>▪ Understanding and safe implementation of circuit diagrams</li> <li>▪ Lay and connect electrical lines</li> <li>▪ Connection of electrical machines, switches, sensors, circuit breakers</li> <li>▪ Analysing and testing electrical systems</li> <li>▪ Assessing the effectiveness of electrical protection measures</li> </ul>
Operation	Operating personnel	<ul style="list-style-type: none"> <li>▪ Instructions for occupational safety and for handling vacuum pumps and compressors</li> </ul>
Maintenance Repair	Maintenance staff	<ul style="list-style-type: none"> <li>▪ Safe handling of tools and materials</li> <li>▪ Disassemble and mount vacuum pumps and compressors</li> <li>▪ Assess damage to vacuum pumps and compressors</li> </ul>
Disposal	Disposal specialist, fitter	<ul style="list-style-type: none"> <li>▪ Decontaminating polluted materials</li> <li>▪ Re-use of materials and substances</li> <li>▪ Correct and environmentally-friendly disposal of materials and substances</li> </ul>

### 2.5.2 Personal protective equipment

 **WARNING**

**Danger of crushing and cutting!**

**Crushing and cutting of body parts due to sharp edges or falling parts on the open L-BL2N.**

1. Wear protective gloves, safety footwear and safety goggles for all assembly and disassembly, troubleshooting and maintenance work.
2. In addition, wear head protection for transportation and overhead work.

 **WARNING**

**Risk of injury!**

**Serious injuries due to body parts and hair being sucked or drawn in (vacuum) or due to projected particles (pressure).**

1. Wear eye protection and tight clothes for all work when in operation.
2. Wear a hair net for long hair.
3. Remove jewellery and rings.

 **WARNING**

**Hearing damage!**

**Hearing damage due to time spent in noisy area under adverse operating conditions or due to noise caused by conveyed media being discharged from the gas outlet or piping.**

- ① Wear ear protection when remaining in the excessive noise area.

## 2.6 Requirements of the operator



### WARNING

#### **Destruction due to bursting or exploding!**

**Any machine that is operated at a pressure or speed that is beyond that which is permitted can explode or burst and cause serious injuries due to parts flying off and conveyed media being suddenly ejected.**

1. The operator must ensure that the pressure differences that affect L-BL2N are not exceeded.
2. The operator must ensure that the revolutions [→ 37] are not exceeded.

### WARNING

#### **Risk of injury!**

**As the L-BL2N is not air-tight, conveying material other than air can lead to severe or fatal injuries (e.g.: asphyxiation, burns).**

- ① Adhere to the safety measures described for the material being conveyed (if necessary, check leakage rates and provide for gas monitoring or forced ventilation).

The operator ensures that:

- All work on the L-BL2N is carried out by:
  - personnel that have the necessary Personnel qualifications and training [→ 9]
  - personnel that have been sufficiently informed of these instructions and all related documents [→ 6]
- Assignment, responsibility and supervision of personnel is regulated.
- The content of these and locally applicable instructions are always available to personnel.
- Personnel are informed of possible dangers related to conveyed material and the necessary safety precautions.
- All local and plant-specific safety measures are complied with:
- The free drawing in or emission of the conveyed media does not place any personnel in danger.
- Dangers due to electrical energy are not possible.

## 3.1 Structure of the type description

### 2BL2041 – 141

**2BL2 141 - 2 A K 5 0 - 6 B - Z**

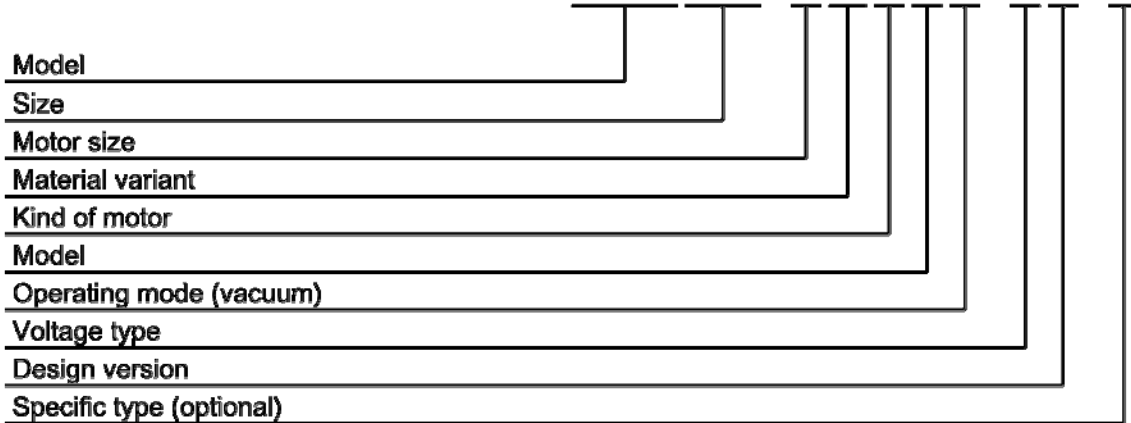

### 2BL2251 – 341

**2BL2 341 - 0 K K 0 3 - 6 B - Z**

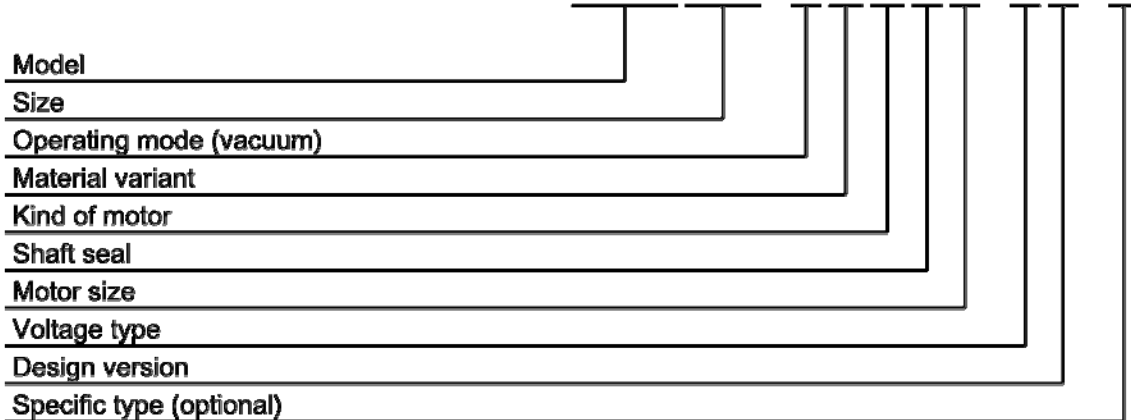

## 3.2 Rating plate

### Rating plate L-BL2N (item 2005, [→ 14])

<b>Gardner Denver</b> vacuum pump			GD Deutschland GmbH Industriestraße 26 97616 Bad Neustadt - Germany
Type:	2BL2..... B		A L-BL2
No.	BN XXXXXXXX XXX / XXXX C		
Motorbem.Leistung/Rated output of motor:	F <sub>1</sub> xxx / xxx kW		
min.Ansaugdruck/Minimum intake pressure:	xx mbar p		
XXXXXXXXXXXXXXXXXX N		Made in Germany	

### Rating plate for the pump (item 2000, [→ 14])

<b>Gardner Denver</b> compressor / vacuum pump		L.BV: B 2BV.....-Z M	XXXXXXXXXXXXXXXXXXXX					
N C 3N XXXXXXXX XXX/XXXX			XXXXXXXXXX N XXXXXXXX					
Hz	kW	SF	V	A	r.p.m.	P.F.	P mbar abs.	IEC/EN 60034 IP xx
E	F <sub>1</sub>	W	G	H <sub>1</sub>	K	J	p	
								Made in Germany

### Rating plate for the motor (item 2001, [→ 14])

<b>Gardner Denver</b>		3 - Motr B GD.....-Z	S NES1XXXXXXXX					
No. BN XXXXXXXX XXX/XXXX C			V T CC 032A					
IEC/EN 60034 IP xxx		CL. xxx D						
Hz	[kW]	r.p.m.	V	A	P.F.	nom. eff.	CODE	U NEMA MG1-12 CONT DESIGN A TEFC SF=xxx 60HZ xxx HP
50	xxx	xxx	xxx-xxx YY	xxx	xxx	IE3 xxx%	xxx	
E	F <sub>2</sub>	K	xxx-xxx Δ	H <sub>2</sub>	J	O	R	
60	xxx	xxx	xy-xxx Y	xxx	xxx	IE3 xxx%	xxx	
60	xxx	xxx	xx-xxx Δ	xxx	xxx	NP xxx%	xxx	
			xxx-xxx YY	xxx	xxx			Made in Germany

- A Series
- B Type
- C Serial number/year of manufacture
- D Machine type, protection class, thermal class
- E Frequency
- F<sub>1</sub> Pump performance requirement
- F<sub>2</sub> Measured power output
- G Voltage
- H<sub>1</sub> Maximum current
- H<sub>2</sub> Rated current
- J Power factor
- K Rated rpm
- p Intake pressure
- M Manufacturer's recommendations (optional)
- N Customer information (optional)
- O Nominal efficiency
- Q Serial number/year of manufacture as DMC code
- R Ratio of breakaway starting current to apparent power
- S Family type number for CC registration
- T CC registration
- U NEMA rating
- W Service factor

## 3.3 Design of the machine

### 2BL2041 – 2BL2141

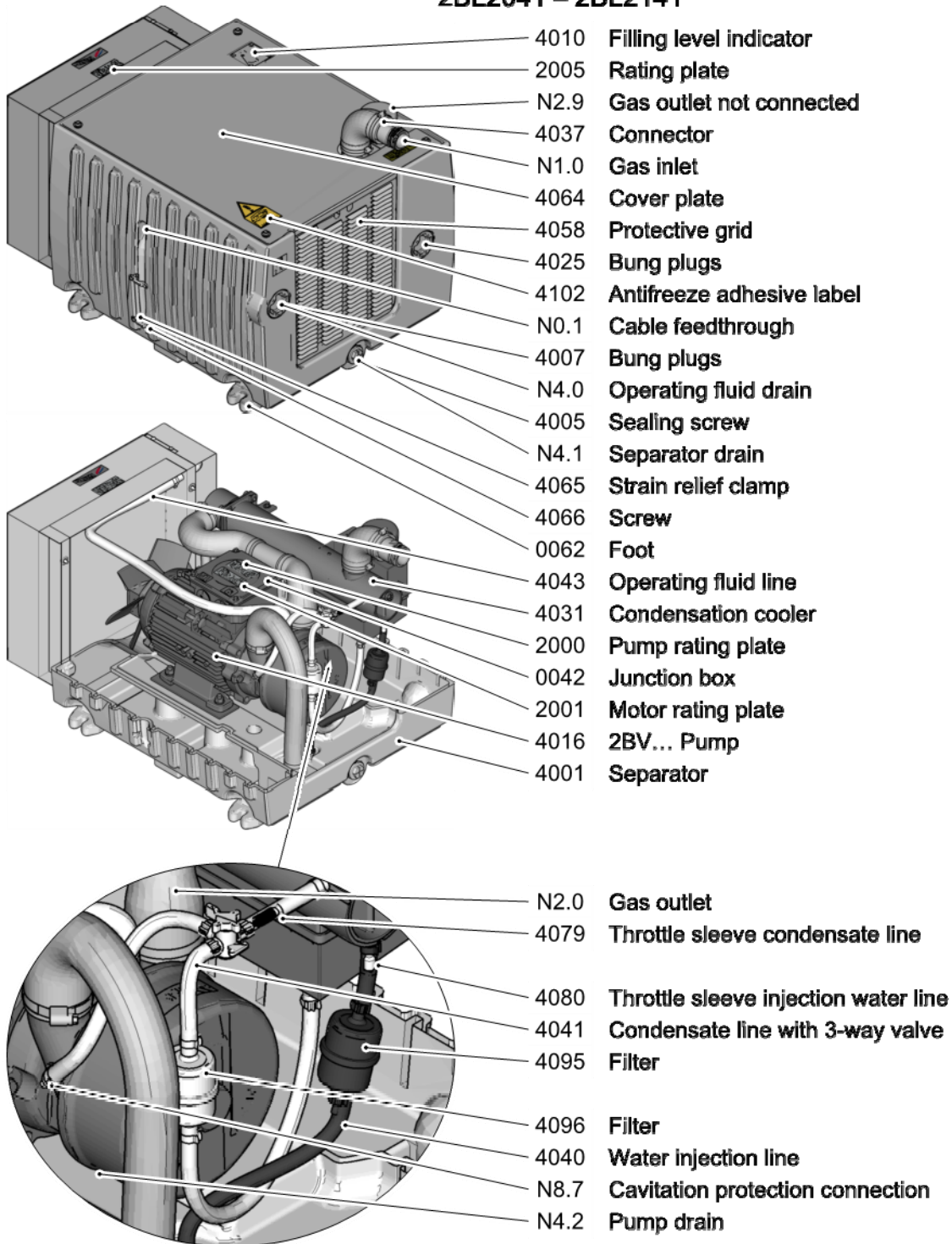

**2BL2251 – 2BL2341**

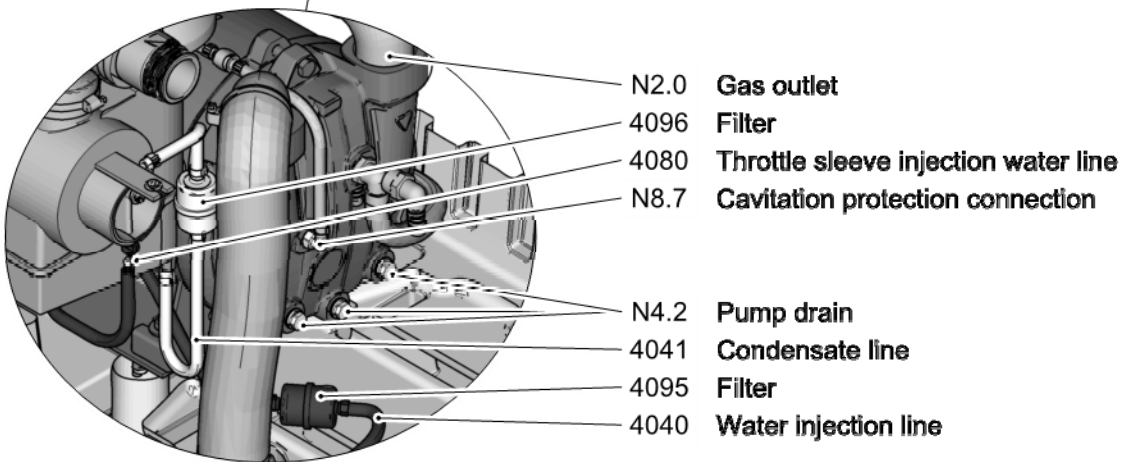
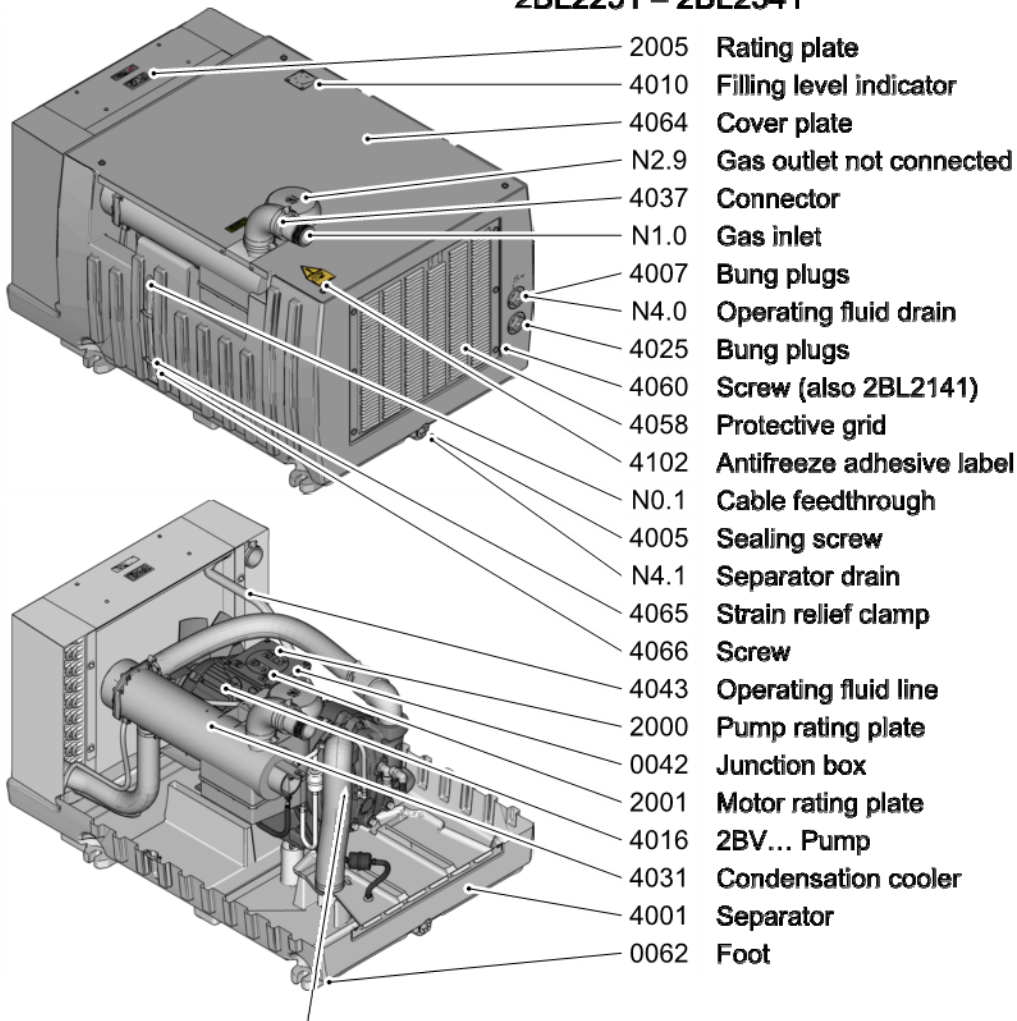

**2BL2341**

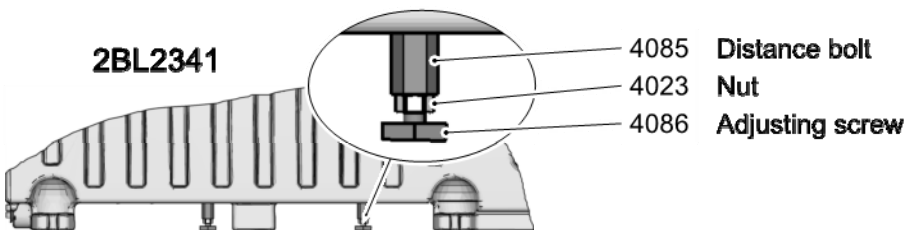

#### 3.4 Function principle

The L-BL2N is a compact, ready to connect vacuum pump and compressor circuit. It consists of a liquid ring vacuum pump that is installed in a fluid separator. The L-BL2N runs air-cooled, 100% oil-free and with no additional water requirement. The conveyed media is compressed without contact and makes the L-BL2N almost maintenance-free.

Due to the exhaust air cooling, the exhaust air has maximum room temperature or is cooler and is cleaned, antistatic and dust-free.

With liquid ring vacuum pumps/compressors, the L-series rotates the impeller (4) eccentrically and contact-free in the pump casing (2). A rotating liquid ring (1) seals the impeller blades in relation to each other and on the front side. This liquid ring will be generated through the rotation of the impeller and is in contact with the pump casing.

Due to the eccentric position of the impeller, the scoop room between the impeller blades (5) alters during rotation. With a full turn the conveyed media will be extracted, compressed and expelled. The conveyed media gushes through the extractor vent (6) in the blade cells and is expelled through the pressure vent (3).

To stabilise the liquid ring and dissipate heat, liquid is constantly extracted from or pushed into the suction chamber and discharged with the propellant gas.

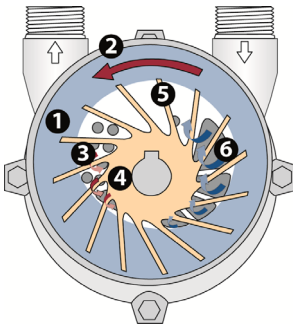



### 3.5 EC/EU declaration of conformity

<b>Manufacturer:</b>	Gardner Denver Deutschland GmbH Industriestraße 26, 97616 Bad Neustadt, Germany		
<b>Representative for the compilation of technical documents:</b>	Holger Krause, Gardner Denver Deutschland GmbH Industriestraße 26, 97616 Bad Neustadt, Germany		
<b>Designation of the machine:</b>	Vacuum Pump		
	Series	L-BL2N	
	Types	2BL2041	2BL2061
		2BL2101	2BL2141
		2BL2251	2BL2281
		2BL2341	

**The manufacturer bears sole responsibility for issuing this declaration of compliance. The machine described above complies with all applicable harmonisation legislation of the Community:**

**2006/42/EC, OJ L 157, 9.6.2006** Directive 2006/42/EC of the European Parliament and of the Council of 17 May 2006 on machinery, and amending Directive 95/16/EC

**harmonised standards and other technical specifications on which the declaration of compliance is based:**

<b>EN 1012-1:2010</b>	Compressors and vacuum pumps - Safety requirements - Part 1: Compressors
<b>EN 1012-2:1996 +A1:2009</b>	Compressors and vacuum pumps - Safety requirements - Part 2: Vacuum pumps
<b>EN ISO 12100:2010</b>	Safety of machinery - General principles for design - Risk assessment and risk reduction (ISO 12100:2010)
<b>EN 60204-1:2006/ A1:2009/ AC:2010</b>	Safety of machinery; electrical equipment for machinery part 1: General requirements IEC 60204-1:2005 (amended)
<b>EN 60034-1:2010/ AC:2010</b>	Rotating electrical machines - Part 1: Rating and performance IEC 60034-1:2010 (amended)

Signed for and on behalf of: Gardner Denver Deutschland GmbH

Bad Neustadt, 20.06.2017

*(Place and date of issue)*



**Caroline Seit, Operations/Authorised signatory**  
*(Name and function)*

664.00186.40.000

## 4.1 Unpacking and checking the condition of delivery

The L-BL2N is secured onto a pallet and protected by a cardboard box for delivery.

1. Remove the packaging, except for the transport protection on the connection openings.
2. Check the delivery for transport damage.  
**NOTICE! Report any transport damage to the manufacturer immediately.**
3. Check that the delivery matches the order.
4. Loosen the fixing screws on the foot (item 0062, [→ 14]).
5. Dispose of packaging material in accordance with the valid local regulations.

## 4.2 Lifting and transporting

### **WARNING**

**Danger of crushing and cutting!**

**Danger of crushing and cutting of body parts due to tipping or falling loads during transportation.**

1. Only transport L-BL2N in a horizontal position.
2. The load-bearing capacity of the lifting gear and load-handling equipment must correspond to the mass [→ 39].
3. Secure against tipping over or falling.
4. Do not remain under supported loads.
5. Set up the L-BL2N on a stable and level surface.

### **NOTICE**

**Mechanical damage!**

**L-BL2N can be damaged during transportation.**

- ! The L-BL2N is designed for transport with a crane or forklift.
- ⓐ The L-BL2N should not be exposed to impacts and blows during transportation.

### **Transportation with a crane**

1. Disconnect mounted accessories (e.g. gas ejector, suction filter) before transporting the L-BL2N.
2. Use lifting straps that are sufficiently long (spread angle of less than 90°).
3. Guide the lifting straps under the preformed indentations of the separator (item 4001, [→ 14]).  
**! WARNING! Ensure that the lifting straps cannot slip off!**
4. Lifting and transporting the L-BL2N.
5. Set the L-BL2N down and, if necessary, secure from slipping and falling.
6. Remove the lifting straps.



### 4.3 Storage

***NOTICE***

**Mechanical damage and corrosion!**

**Failure to adhere to the storage conditions can lead to mechanical damage and corrosion, as well as shorten the grease service life.**

1. Adhere to storage and standstill conditions.
2. The maintenance intervals of the ball bearings (Maintenance [→ 33]) become shorter as the time of storage increases.

1. Connect all suction vents so that no dirt or solid particles can enter.
2. Turn the rotor once per year so as to avoid permanent standstill marks.

Storage conditions	Permitted values	
Ambient pressure	Atmospheric	
Composition of the environment	Dry, dust-free environment (relatively humid < 60%)	
Ambient temperature	<b>+5°C to +40°C</b>	+41°F to +104°F
Static loads	None	
Abrupt impacts	None	
Speed of oscillation $V_{\text{eff}}$	<b>&lt;1.5 mm/s</b>	<0.059 in/s

## 5.1 Measures after long-term storage

### Replace ball bearings and radial shaft seal

! When the length of storage until assembly is exceeded by **4 years** for the storage conditions provided in Storage [→ 19].

1. Replace the rolling bearing.
2. Clean adjacent bearing areas for open ball bearings and re-grease.
3. Replace and grease the radial shaft seal.

If the bearing conditions vary (Storage [→ 19]), a reduced ball bearing service life is to be expected.

### Measuring the motor insulation resistance

- ① Measure the insulation resistance of the motor at 500V DC voltage between the conductors of the main circuit and protective conductive system.
  - ✓ Value  $\geq 1 \text{ M}\Omega$ : no measures necessary.
  - ✓ Value  $< 1 \text{ M}\Omega$ : Dry winding.

### Remove the corrosion inhibitor

L-BL2N, which was filled with corrosion inhibitor for storage must be drained and cleaned.

1. Drain the corrosion inhibitor as described in chapter Draining down [→ 35] and dispose of it in accordance with the manufacturer's specifications.
2. Flush the [→ 33] L-BL2N.

## 5.2 Mounting conditions

For safe operation, comply with the following installation conditions

- Always place the L-BL2N on a level mounting surface or base frame. The dimensions and load bearing capacity must be designed for L-BL2N.
- When installing outdoors, take protective measures against the effects of weather.
- When installing in enclosed spaces, ensure that there is sufficient ventilation. For conveyed media other than air, leaks from the L-BL2N must be taken into account (e.g. forced ventilation, gas monitoring).
- No exhaust air from other machines in the suction area of the motor fan.
- External oscillations, abrupt loads and accelerations are not permitted.
- External mechanical loads are not permitted on the L-BL2N and its attachments (e.g. piping without a support, climbing the L-BL2N and its attachments).

## 5.3 Reduction of oscillations and noises

Noise emissions and vibrations can be reduced by the following measures.

- Do not set up the L-BL2N in set-up areas that conduct or radiate sound.
- Mount the L-BL2N on a secure foundation or a solid surface.
- Equip installation surfaces with intermediate layers of noise damping material.

## 5.4 Level assembly on the foot

- ! Always mount the L-BL2N with the feet downwards (no wall or ceiling assembly).
- 1. Only 2BL2341: All four adjusting screws (item 4086, [→ 14]) must lie on the installation surface.
- 2. Only 2BL2341: Tighten the nuts (item 4023, [→ 14]).
  - ✓ **13.5 – 16.5 Nm** (9.96 – 12.2 ft lbs)
- ! When installing above floor level, the L-BL2N must be screwed to the installation surface.
- 1. Mark the fixing points through the holes in the foot (item 0062, [→ 14]) or by referring to the dimensional drawing.
- 2. Lift the L-BL2N away and drill the holes for the fixing points.
- 3. Place the L-BL2N with the foot in assembly position.
- 4. Screw the foot to all anchorage holes with fastening elements.
  - ✓ Screw M12 steel (8.8 according to ISO 898-1): **18 – 22 Nm** (13.3 – 16.2 ft lbs) and washer according to ISO 7093-1

## 5.5 Mount the accessories

- ① Mount accessories according the instruction manual supplied with the respective accessory.

## 5.6 Connecting pipelines and hoses

### **NOTICE**

#### **Pressure loss due to reduced cross section of the pipes and hoses!**

- ① As possible, make the cross section of the pipes and hoses the same length or longer than the connections of the L-BL2N.

### **NOTICE**

#### **Due to negative pressure in the system, return flows of operating fluid and dry operation of the rotary seal!**

**Once switched off, negative pressure in the system can drain the built-in pump and draw operating fluid into the system. When recommissioning, the then dry running rotary seal can be destroyed in seconds.**

! L-BL2N with option S25 have no internal non-return valve.

- ① Install a suitable non-return valve in the suction line.

The conveyed material is sucked in via the gas inlet (item N1.0, [→ 14]) and discharged via the gas outlet (item N2.0, [→ 14]).

The L-BL2N can be fitted with pipes or hoses.

**Connection dimensions for gas inlet (item N1.0, [→ 14])**

Type	Pipe thread [EN 10226]	Hose connection [mm (in)]
2BI2041	R ¾	32 (1.26)
2BL2061 – 2BL2141	R 1¼	50 (1.97)
2BL2251 – 2BL2341	R 2	63 (2.48)

! On delivery, all connection openings are closed with a transport protection. This prevents foreign objects from entering.

1. Remove the transport protection from the connection openings.
2. For impurities in the conveyed media, fit a filter (accessories) in the suction line.
3. The gas outlet (item N2.0, [→ 14]) is not connected. The protective cap must not be removed.
4. For the hose connection, loosen the hose clip on the connector (item 4037, [→ 14]) and turn the connector by 180°. Tighten the hose clip.  
✓ **2.7 – 3.3 Nm** (2.00 – 2.43 ft lbs)
5. Connect the pipe or hose of the system suction line to the gas inlet (item N1.0, [→ 14]).

**Non-return valves**

In the case of operational shutdown, a non-return valve prevents the return flow of conveyed media from the L-BL2N. In the following cases, a non-return valve must be provided at the gas inlet (item N1.0, [→ 14]).

- Two or more L-BL2N are operated in parallel. Each L-BL2N must have its own non-return valve at the gas inlet.
- If a vacuum can occur in the connected suction line for more than **1 min** when the L-BL2N is shut down.

## 6.1 General installation regulations



### DANGER

#### **Lethal electric shock on the housing due to the air gap being too small!**

! Air gaps between non-insulated, voltage active components and the earth must be at least **5.5 mm** [0.217 in] to one another (for a measured voltage of  $U_N \leq 690$  V).

1. Avoid projecting cable ends.
2. Ensure electrical connections are durably resilient.



### DANGER

#### **Lethal electric shock due to contact voltage on the housing!**



1. Implement protection from contact voltage according to IEC 60204-1. Use the earth connection in the junction box (equipotential bonding protection).
2. If necessary, connect the equipotential bonding bar to the outer earth connection (item 1100, [→ 14]).
3. Keep the junction box free of foreign objects, dirt and moisture.
4. Seal junction box lid and cable feed openings so that they are dust and water tight.

### *NOTICE*

#### **Destruction of the drive!**

#### **Incorrect operation or incorrect control can destroy the drive.**

1. The L-BL2N is equipped with an **asynchronous motor**.
2. Operating on a grid with a non-earthed start point is not permitted.

The electrical installation must properly fulfil the requirements of IEC 60204-1, IEC 60204-11 and IEC 61010-1.

The electrical installation must also be implemented according to the applicable national, local and plant-specific stipulations, as well as the requirements of the power supply company.

The conditions at the place of use must comply with the details on the rating plate (item 2000, [→ 13]) or for IE3 operation, on the motor rating plate (item 2001, [→ 13]).

The following conditions without loss of performance are permitted during mains operation:

- $\pm 5\%$  variation in voltage according to EN 60034-1 range A for IE3 motors
- $\pm 10\%$  variation in voltage according to EN 60034-1 range B for IE3 motors
- $\pm 2\%$  deviation in frequency

The electrical installation must:

- Be designed in accordance with the ambient and operating conditions (amperage)
- Be correctly attached and protected.
- Be kept away from hot surfaces.
- Be electrically isolated to a sufficient degree.

- Be constructed and fitted in such a way that the following faults do not lead to damage:
  - short circuits
  - mechanical impacts
  - power supply failures or surges
  - electromagnetic fields
  - earth connections

The electrical equipment and control must not put the protective devices of the drive system and the motor protection (e.g. PTC resistor, bimetal switch, frequency inverter current limit) out of operation.

When the power supply fails or surges, the control must prevent the L-BL2N from remaining in operation or starting up.

Protective devices and switches must fulfil the failure safety conditions.

### Overcurrent protection

The power supply of the motor must be equipped with an overcurrent protection device (e.g. a motor protection circuit breaker) according to IEC 60204-1, 7.2.

Set the overcurrent protection device to the maximum current (item H<sub>1</sub>, [→ 13]).

### Separator for the electrical energy supply

A separator for the electrical energy supply must be:

- Provided according to IEC 60204-1, 5.3 and 5.5.
- Clearly and visibly labelled.

## 6.2 Controls

Controls and instruments must be constructed and arranged in such a way that:

- They are easily visible and accessible, and can also be operated without excessive effort.
- The operator understands the functions.
- Operating faults are prevented.

A control system must correspond to ISO 12100, 4.11; IEC 60204-1, 9.4 and ISO 13849-1.

When the power supply fails, a "system with oriented failure mode" according to ISO 12100, 6.2.12.3 must be used.

Start and stop devices must be clearly marked in accordance with ISO 13850 and IEC 60417.

### EMERGENCY OFF function

An EMERGENCY OFF function must be provided when a dangerous situation can occur that must be rectified manually (see ISO 12100, 6.3.5.2)

- Implement the EMERGENCY off function according to EN 418 and EN 50099.
- Implement a manual EMERGENCY OFF function according to ISO 13849-1, 5 (in particular 5.2.1).
- The stop category and colour of the EMERGENCY OFF function must correspond to ISO 13850.
- If a risk assessment determines that the normal switch can fulfil the EMERGENCY OFF function, this should be labelled accordingly.

After an EMERGENCY OFF, start-up is only possible via a deliberate, manually-triggered procedure.



## Manual reset

A manual reset after a stop command must correspond to ISO 13849-1, 5.5.2 and IEC 60204-1, 9.2.5.3 and 9.2.5.4.

## Start and new start

The requirements of a start and new start, must correspond to ISO 13849-1, 5.2.3.



If the L-BL2N is equipped with an automatic or remote-controlled start control, it must be labelled with the sign to the left.

It is necessary to prevent an automatic or remote-controlled start during maintenance or repair.

## 6.3 Connect the motor to the mains

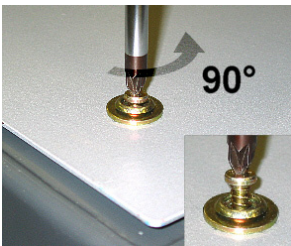

1. Turn the closure plug (item 4061, [→ 14]) 90° in anti-clockwise direction.
  2. Remove the cover plate (item 4064, [→ 14]).
  3. Open the junction box cover.
  4. Open access points for cable glands.
  5. Screw in or insert cable glands and secure with locknut. Screw in fit reducer, if available.
- NOTICE! The cable glands and fit reducers may not lower the IP protection class.**

6. Insert **flexible** cable to be connected through the cable feedthrough (item N0.1, [→ 14]) and cable glands into the junction box (item 0042, [→ 14]).
7.  Provide cable to be connected with cable lugs or eyelets.
8. Connect the protective cable to the designated position with the symbol to the left.



- ✓ M4: **4.0 – 5.0 Nm** (2.95 – 3.70 ft lbs)
- ✓ M5: **7.5 – 9.5 Nm** (5.55 – 7.00 ft lbs)
9. Attach mains connecting line and connecting rails according to the circuit diagram in the junction box (item 0042, [→ 14]) or motor protection circuit breaker and the following figures.
  - ✓ M4: **0.8 – 1.2 Nm** (0.60 – 0.90 ft lbs)
  - ✓ M5: **1.8 – 2.5 Nm** (1.35 – 1.85 ft lbs)
10. If available, connect PTC resistor, bimetal switch and electric band heater according to the circuit diagram in the junction box (item 0042, [→ 14]) and the follow figures. Use a PTC resistor evaluation unit to evaluate the PTC resistor.
11. Remove any unused connecting rails from the junction box.
12. Tighten cable glands according to manufacturer's specifications.
13. Seal any openings with O-rings or suitable flat seals.
14. Close the junction box cover.
  - ✓ M4: **4.0 – 5.0 Nm** (2.95 – 3.70 ft lbs)
  - ✓ M5: **7.5 – 9.5 Nm** (5.55 – 7.00 ft lbs)
15. Tighten the strain relief clamp (item 4065, [→ 14]).
  - ✓ **0.72 – 0.88 Nm** (0.53 – 0.65 ft lbs)
16. Mount the cover plate (item 4064, [→ 14]).
17. Turn the closure plug (item 4061, [→ 14]) 90° in clockwise direction.



## 6 Electric power connection

Connecting two equally thick (single-wire) conductors with terminal clip

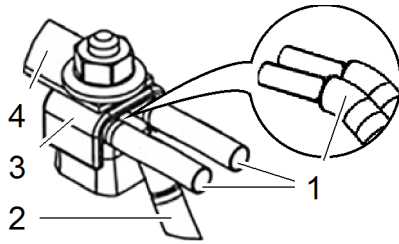

1 = Mains connecting line  
4 = Connecting rail

Connecting one (single-wire) conductor with terminal clip (U-shape)

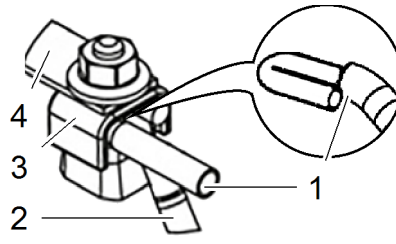

2 = Motor connection cable

Connecting one (fine-stranded wire) conductor with cable lug/eyelet

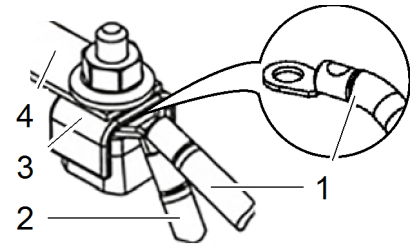

3 = Terminal clip

### 6.4 Connecting accessories

Connect accessories according to the instruction manual supplied with the respective accessory.

## 7.1 Measures after a long shut-down period

### Replace ball bearings and radial shaft seal

! When the downtime exceeds **4 years** since the last commissioning.

1. Replace the rolling bearing.
2. Clean adjacent bearing areas for open ball bearings and re-grease.
3. Replace and grease the radial shaft seal.

If the standstill conditions vary (Storage [→ 19]), a reduced ball bearing service life is to be expected.

### Measuring the motor insulation resistance

- ① Measure the insulation resistance of the motor at 500V DC voltage between the conductors of the main circuit and protective conductive system.
  - ✓ Value  $\geq 1 \text{ M}\Omega$ : no measures necessary.
  - ✓ Value  $< 1 \text{ M}\Omega$ : Dry winding.

## 7.2 Initial filling with operating liquid



### Fill the pump (item 4016, [→ 14])

For the initial filling of the L-BL2N, in addition to the separator, the pump must also be filled with operating fluid.

1. Fill the pump via the gas inlet (item N1.0, [→ 14]) with operating fluid.



### Fill the separator (item 4001, [→ 14])

1. Fill the separator via the operating fluid drain (item N4.0, [→ 14]) with operating fluid.
2. Check the filling level via the filling level indicator (item 4010, [→ 14]).

**NOTICE! Do not fill the separator above pointer position 1.**



## 7.3 Tests during commissioning or re-commissioning

 **CAUTION**

### **Overpressure!**

### **Overpressure during the leak test can damage the L-BL2N.**

① To test the plant for leaks, the L-BL2N must be excluded.

- ① Prior to commissioning or recommissioning of the L-BL2N, check that:
- ✓ The L-BL2N is properly fitted and aligned.
  - ✓ Rotating components move freely.
  - ✓ The interior of the pump is filled with operating fluid.
  - ✓ The separator is filled with operating fluid.
  - ✓ Pipes and hoses are correctly connected.
  - ✓ Attachments, screw fittings and electrical connections are fixed at the given tightening torques.
  - ✓ The operating conditions match the rating plate details given above.
  - ✓ The maximum speeds are monitored and adhered to through the control.
  - ✓ Protection measures against accidental contact have been completed.
  - ✓ Cooling air supply is not affected.

## 7.4 Check the direction of rotation

1. Switch on the L-BL2N briefly and then switch it off again.
2. Check the cooling air outlet at the protective grid (item 4058, [→ 14]).
  - ✓ Cooling air outlet present: direction of rotation is correct, no measures
  - ✓ No cooling air outlet: direction of rotation incorrect, change direction of rotation by interchanging two phases of electrical supply line.

## 7.5 Sensors function check

- ① Check that sensors (e.g. PTC resistor) are connected correctly.

## 7.6 Measure oscillations

- ! It is recommended to measure the oscillations for the prescribed operating speeds.
1. Measure oscillations.
  2. If the permitted Speed of oscillation is exceeded, provide measures for Reduction of oscillations and noises [→ 20].

When operating the L-BL2N, comply with the Permitted conditions for use [→ 37].

## 8.1 Switch on

### *NOTICE*

#### **Destruction of the rotary seal due to dry running within seconds!**

1. Make sure that the interior of the pump is filled with operating fluid.
  2. Make sure that the separator is filled with operating fluid.
- 
1. If fitted, open the shut-off devices in the suction line and supply regulator.
  2. Switch on current supply.
    - ✓ The L-BL2N begins to suction conveyed media.
  3. If the L-BL2N does not generate a vacuum during initial commissioning, briefly throttle the suction side or close it and open it again.

## 8.2 Use in the working process

It is possible to run the system continuously at maximum vacuum and/or minimum intake pressure (against closed suction slide). In doing so, the power consumption of the L-BL2N is at the lowest.

When idling, operation with minimum suction pressure is recommended (lowest power requirement).



### **3-way valve (item 4041, [→ 14]) only 2BL2041–2BL2141**

If operating with low suction pressures  $\leq 200$  mbar ( $\leq 2.90$  psia), the suction power of the L-BL2N can be increased by switching the 3-way valve to the **HIGH VACUUM** position. With suction pressures  $\geq 200$  mbar ( $\geq 2.90$  psia), the **HIGH VACUUM** valve position can lead to injection water formation at the gas outlet (item N2.0, [→ 14]).

### 8.2.1 Loss of operating fluid

With low humidity and high suction pressure  $> 350$  mbar abs. [5.08 psia], the steam content in the outlet gases lies slightly above that in the inlet gases. This results in a low loss of operating fluid

1. Check the operating fluid level in the separator using the filling level indicator (item 4010, [→ 14]) and add if necessary.
2. With **pointer position 0**, switch off the L-BL2N and fill the separator [→ 27].
  - ✓ With **pointer position 0**, the suction capacity reduces and longer operation without operating fluid supply leads to a breaking of the vacuum and then to dry running of the L-BL2N.

#### **Supply regulator**

In the event of a loss of operating fluid, a supply regulator can be connected, through which the fluid level is automatically compensated.

### 8.2.2 Increase in operating fluid

In the event of high humidity and low suction pressure, the steam content in the outlet gases lies slightly below that in the inlet gases. This causes an increase in operating fluid.

When water is conveyed via the gas inlet (item N1.0, [→ 14]), there is also an increase in operating fluid.

- ① Regularly check the operating fluid level in the separator using the filling level indicator (item 4010, [→ 14]) and if necessary drain it via the operating fluid drain (item N4.0, [→ 14]).

**NOTICE! Overfilling cannot be checked via the filling level indicator!**

#### Drain regulator

With an increase in operating fluid, a drain regulator **must** be connected, through which the fluid level is automatically compensated.

### 8.3 Switch off

- ! The L-BL2N can be switched off in each operating condition (i.e. regardless of pressure, temperature, etc.). In doing so, the working process of the system must be observed.
- 1. Switch off current supply.
  - ✓ The L-BL2N interrupts the suction of the conveyed media. The impeller gradually stops and the pressure is slowly released.
  - ⚠ WARNING! Risk of injury due to rotating impeller: wait until it comes to a stop.**
- 2. If fitted, close the shut-off devices in the suction line and supply regulator.

### 8.4 Switch off in emergency

1. The L-BL2N can be switched off in emergency without any particular precautions.
2. Determine the cause.
3. Rectify the risk.
4. Put the L-BL2N back into operation [→ 27].

**Voiding of the warranty!**

**The opening of the L-BL2N by the operator within the warranty period can lead to voiding of the warranty.**

Fault	Cause	Corrective measure	To be carried out by
L-BL2N does not start up and does not make any noise	The power supply of the L-BL2N was interrupted	Correct the break in fuses, terminals or power supply lines	Electrician
L-BL2N does not start up and makes noises	Break in one of the power supply lines	Correct the break in fuses, terminals or power supply lines	Electrician
	Impeller grinds or rotor is jammed	Open L-BL2N, remove foreign objects, clean or replace parts	Service*
	Faulty impeller	Replace impeller	Service*
	Rolling bearing is faulty	Replace rolling bearing	Service*
L-BL2N turns unevenly	Defective motor cable	Check motor cable	Electrician
Consumption of water increases significantly after longer operating time	Cooler cooling ribs dirty	Clean the cooling ribs (e.g. with compressed air).	Operating personnel
L-BL2N does not generate a vacuum	No operating fluid	Fill up with operating fluid.	Operating personnel
	Leaks	Seal L-BL2N and system.	Fitter
	Incorrect direction of rotation	Change the direction of rotation by switching two electrical power supply lines.	Electrician
L-BL2N generates too little vacuum	Suction line too long or too thin	Use a shorter or thicker line for the suction line.	Fitter
	Leaks in the suction side hose connections or suction line	Check and if necessary seal suction side hose connections and suction line.	Fitter
	Insufficient operating fluid flow	Check the operating fluid line and operating fluid hole of the installed pump for blockages. If necessary, resolve any blockages.	Fitter
	Insufficient operating fluid level in separator	Refill with operating fluid	Operating personnel
	Operating fluid too warm	Clean the cooling ribs.	Operating personnel
	Small leak	Seal L-BL2N and system.	Fitter
	Suction filter (accessory) dirty.	Replace the suction filter.	Fitter
	Vacuum regulation valve (accessory) incorrectly set	Check and correct the vacuum regulation valve setting.	Fitter
	L-BL2N too small	Replace bigger L-BL2N.	Owner
Water sprays out of the gas outlet	Condensate is no longer suctioned	Check the air filter for dirt and if necessary, clean or replace it.	Operating personnel
		Clean the throttle sleeves (items 4079 and 4080) <ul style="list-style-type: none"> <li>▪ Stop the L-BL2N and secure against restart.</li> </ul>	Fitter

Fault	Cause	Corrective measure	To be carried out by
		<ul style="list-style-type: none"> <li>▪ Remove the cover plate (item 4064) and protective grid (item 4058).</li> <li>▪ Loosen the hose connections at the corresponding points.</li> <li>▪ Clean the throttle sleeves (items 4079 and 4080).</li> <li>▪ Blow through the hose lines to the condensation cooler (item 4031) with compressed air.</li> <li>▪ Check the hose line connections at the condensation cooler (item 4031) for continuity.</li> <li>▪ Remount parts and seal the system.</li> </ul>	
	Operating fluid level in the separator too high	With water conveyance, install an automatic drain regulator (accessory). Check the function of the supply regulator (accessory).	Fitter Operating personnel
Consumption of water increases rapidly	Throttle sleeves blocked	Clean the throttle sleeves (items 4079 and 4080) (see above).	Fitter
	Filter blocked	Replace the filters (items 4095 and 4096).	Fitter
	Cooler cooling ribs dirty	Clean the cooling ribs (e.g. with compressed air).	Operating personnel
L-BL2N does not reach the required speed or shows no or too little differential pressure	Incorrect direction of rotation	Check [→ 28] the direction of rotation.	Electrician
	Fluctuating density of conveyed media.	Take into account recalculation of pressure values; consult the manufacturer.	Manufacturer
	Clogged filters or silencer elements	Clean filters and silencer elements and replace them, if necessary	Fitter
	Leaks in the unit	Seal the unit	Fitter
	Radial shaft seal is defective	Replace the radial shaft seal	Service*
	Change in the blade profile due to contamination	Clean the impeller, check for wear and replace if necessary	Service*
Abnormal flow noises	Flow rate too high	Clean pipe/hoses, use pipes/hoses with a larger cross section if necessary	Fitter
Abnormal running noises or oscillations	Rolling bearing in motor or in compressor part needs grease or is faulty	Relubricate or replace the rolling bearing	Service*
Vibrations too high	Rolling bearing is faulty	Replace rolling bearing	Service*
	Deposits on the impeller	Clean the impeller	Service*
L-BL2N leaks	Screw connections loose on the gas outlet or gas inlet or on the compressor cover	Check tightening torques and tighten screws	Fitter
	Radial shaft seal is defective	Check the radial shaft seal and replace if necessary	Service*

\* To be corrected by maintenance staff if the maintenance manual is available.



## 10.1 Maintenance

For the safe operation of the L-BL2N, the following maintenance intervals are recommended. They are dependent on the operating conditions and must be adjusted by the user as necessary.

Maintenance interval	Maintenance measure	To be carried out by
Depending on the amount of dirt (at least every 1000 h)	① <b>Exterior:</b> Check cooler cooling ribs, surfaces and attachments for deposits and clean if necessary (e.g. with compressed air).	Operating personnel
	① <b>Interior:</b> Check any areas that convey material for deposits and clean or replace if necessary.	Fitter
Depending on amount of dust.	① Replace operating fluid contaminated by dust with fresh operating fluid.	Operating personnel
Annually	① Check the control for error messages by disconnecting the sensors (e.g. bimetal switch, PTC resistor). Remedy the cause of the error for any malfunctions.	Electrician
dependent on the concentration of contaminant particles in the operating fluid	① Install separator, filter or strainer in the supply line.	Fitter
	<b>Flush</b> the L-BL2N. <ol style="list-style-type: none"> <li>1. Shut down the L-BL2N.</li> <li>2. Remove system pipes and hoses.</li> <li>3. Attach hoses for flushing liquid to the operating fluid supply (item N3.0, [→ 14]) and to the gas outlet (item N2.0, [→ 14]).</li> <li>4. Place a drain-off container underneath the pump drain (item N4.2, [→ 14]) and the separator drain (item N4.1, [→ 14]).</li> <li>5. Open the pump drain and separator drain.</li> <li>6. Use a clean, non-hazardous medium (e.g. water) for flushing. Feed in the flushing liquid through hoses. The impurities are flushed out of the pump casing/separator with the flushing liquid. Continue to rinse until the flushing liquid is free of impurities.</li> <li>7. Remove hoses.</li> <li>8. Close the screw plugs of all drain tapings. Torque: <b>2 ... 3 Nm</b> [1.48 ... 2.21 ft lbs].</li> <li>9. Mount pipes and hoses and return the L-BL2N to its original operating condition.</li> </ol>	Operating personnel

Maintenance interval	Maintenance measure	To be carried out by
Depending on the hardness of the water in the operating fluid (monthly lime content > 15 °dH/ hardness of water > 2.675 mmol/l [ $> 267$ ppm])	① Soften operating fluid.	Operating personnel
	<b>Descale</b> the L-BL2N <ol style="list-style-type: none"> <li>1. Put on personal protective gear (gloves and safety goggles).</li> <li>2. Shut down the L-BL2N.</li> <li>3. Drain the [→ 35] L-BL2N.</li> <li>4. Remove pipes and hoses from gas inlet (item N1.0, [→ 14]).</li> <li>5. Use 10 % citric acid or another commercially available citric-acid-based descaling agent (e.g. Sotin 212) for the descaling fluid.</li> <li>6. Fill L-BL2N with descaling fluid via gas inlet (filling level = scale level).</li> <li>7. Let the L-BL2N run briefly with the dismantled gas inlet and sealed supply line and drain (item 4007, 4025, [→ 14]), until the descaling fluid has been distributed. Allow the descaling fluid to take effect for at least four hours.</li> <li>8. Drain the descaling fluid.</li> <li>9. Check whether the scale has been removed. If necessary, repeat steps 5 to 8.</li> <li>10. Flush the [→ 33] L-BL2N.</li> <li>11. Mount pipes and hoses at the gas inlet and return the L-BL2N to its original operating condition.</li> <li>12. Start up the L-BL2N.</li> <li>13. Dispose of the descaling agent in accordance with the applicable directives.</li> </ol>	Operating personnel

\* Maintenance and repair by qualified personnel is possible when the repair manual is available.

## 10.2 Repairs and complaints

Please consult the service department regarding repairs and complaints before sending them to the manufacturer.

- Gardner Denver Deutschland GmbH  
Industriestraße 26  
97616 Bad Neustadt  
Tel.: +49 9771 6888 2000  
Fax: +49 9771 6888 11 2000  
E-mail: er.service-nes@gardnerdenver.com  
Internet: www.gd-elmorietschle.com

## 10.3 Ordering spare parts

---

**Spare parts order as per repair manual [→ 6].**

---

## 11.1 Decommissioning

! The L-BL2N can remain in the unit or be dismantled for storage.

1. Disconnect the L-BL2N from the power supply.
2. Depressurise the pipes.

### 11.1.1 Draining down

1. Turn the closure plug (item 4061, [→ 14]) 90° in anti-clockwise direction.
2. Remove the cover plate (item 4064, [→ 14]).
3. If present, remove the screws (item 4060, [→ 14]).
4. Remove the protective grid (item 4058, [→ 14]).
5. Open the operating fluid drain (item N4.2, [→ 14]).
6. Open the operating fluid drain (item N4.1, [→ 14]).
7. Open the cooler drain.
8. Allow the operating fluid to drain.
9. Close all drain openings.
10. Mount the protective grid.
11. If present, mount the protective grid screws.
  - ✓ 2BL2141: **2.7 – 3.3 Nm** (2.00 – 2.43 ft lbs)
  - ✓ 2BL2151–2BL2341: **8.1 – 9.9 Nm** (5.98 – 7.30 ft lbs)
12. Mount the cover plate (item 4064, [→ 14]).
13. Turn the closure plug (item 4061, [→ 14]) 90° in clockwise direction.

### 11.1.2 Corrosion inhibitor for storage

For standstill times >4 weeks or in the event of frost hazard, fill the L-BL2N with corrosion inhibitor.



1. Turn the closure plug (item 4061, [→ 14]) 90° in anti-clockwise direction.
2. Remove the cover plate (item 4064, [→ 14]).
3. If present, remove the screws (item 4060, [→ 14]).
4. Remove the protective grid (item 4058, [→ 14]).
5. 2BL2041–2BL2141: Remove the hose from the gas outlet (item N2.0, [→ 14]).
6. 2BL2251–2BL2341: Loosen the hose clip and remove the hose from the condensation cooler (item 4031, [→ 14]).
7. Use a funnel to pour corrosion inhibitor into the gas outlet or hose Filling quantities [→ 38].



8. During filling, rotate the fan impeller by hand approx. one turn.
9. Mount the removed hoses.
  - ✓ **2.7 – 3.3 Nm** (2.00 – 2.43 ft lbs)
10. Mount the protective grid.
11. If present, mount the protective grid screws.
  - ✓ 2BL2141: **2.7 – 3.3 Nm** (2.00 – 2.43 ft lbs)
  - ✓ 2BL2151–2BL2341: **8.1 – 9.9 Nm** (5.98 – 7.30 ft lbs)
12. Mount the cover plate (item 4064, [→ 14]).
13. Turn the closure plug (item 4061, [→ 14]) 90° in clockwise direction.

## 11.2 Disassembly

1. Disconnect the L-BL2N from all electrical connections.
2. Dismantle the piping and hoses.
3. Close connections that are open.
4. Store [→ 19] or dispose of [→ 36] L-BL2N.

## 11.3 Disposal

 **WARNING**

**Burns, chemical burns or poisoning!**

**Risk of injury due to contact with residual hazardous substances in the L-BL2N.**

① Decontaminate the L-BL2N as instructed by the manufacturer of the hazardous substances.

1. Do not mix solvents, descaling agent, antifreeze, residual lacquer and grease, and dispose of them in accordance with the valid local regulations.
2. Dispose of components according to the valid local regulations or recycle them.

## 12.1 Permitted conditions for use

Any deviations from the following **permissible operating conditions** must be agreed with the manufacturer.

### 12.1.1 Installation height

The maximum installation height is **1000 m above sea level. NHN** (3280 ft above sea level) provided no other installation height is specified on the rating plate [→ 13] under item M.

### 12.1.2 Rotational speeds

For speed, see rating plate (item K), [→ 13].

### 12.1.3 Temperatures

#### Temperature of the conveyed media

Minimum		Maximum	
[°C]	[°F]	[°C]	[°F]
+5	+41	+60	+140

#### Ambient temperature

Minimum [°C] with antifreeze		Minimum [°C] without antifreeze		Maximum	
[°C]	[°F]	[°C]	[°F]	[°C]	[°F]
-20	-4	+10	+50	+40	+104

With ambient temperatures **< 10°C** [+50°F], there is a danger of icing.

Enrich the operating fluid with antifreeze based on ethylene glycol (e.g. Antifrogen from Clariant) according to the label on the cover plate (item 4102, [→ 14])

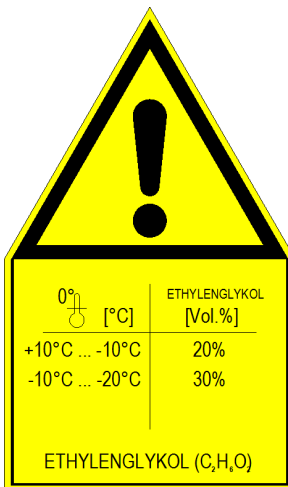

### 12.1.4 Vacuum operation pressures

#### Suction pressure p with vacuum operation

Minimum		Maximum	
[mbar]	[psia]	[mbar]	[psia]
50	0,725	800	11.6

With suction pressures **>350 mbar** (>5.08 psia), the steam content in the outlet gases can lie above that in the inlet gases.

This loss of water can be automatically compensated with a supply regulator.

### 12.1.5 Relative humidity

#### Ambient relative humidity

Maximum **60%** at **+40°C** (+104°F)

#### Relative humidity of conveyed media

Condensate formation is not permitted in the internal space of the L-BL2N.

## 12.1.6 Minimum distances for heat dissipation

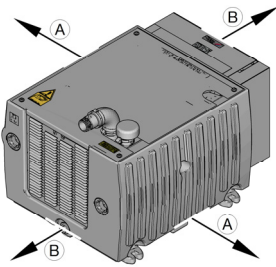

Adhere to the following minimum distances for heat dissipation:

[mm]		[in]	
A	B	A	B
10	400	0.40	15.75

## 12.1.7 Speed of oscillation



The maximum permitted speed of oscillation for the installed L-BL2N is  $v_{\text{eff}} = 4.5 \text{ mm/s}$  [0.177"/s].

Determine the vibration speed at the projected measuring points.

## 12.1.8 Accelerations

**Maximum permissible acceleration for the constructed machine**

0.3 x g

**NOTICE!** The rolling bearings can be destroyed by excessive alternating stresses.

## 12.2 Electrical data

Any deviations from the following **electrical data** must be agreed with the manufacturer.

The electrical data are provided on the rating plate [→ 13].

### 12.2.1 Increased operating cycle frequency

The L-BL2N is designed for heavy-duty operation. Consultation with the manufacturer is necessary for increased operating cycle frequency.

## 12.3 Filling quantities

### 12.3.1 Quantity of operating fluid for first fill

Type	Separator maximum		Pump maximum	
	[l]	[gal(US)]	[l]	[gal(US)]
2BL2041	22.5	5.95	1.5	0,395
2BL2061   2BL2101	43.5	11.5	1.5	0,395
2BL2141	57.5	15.2	1.5	0,395
2BL2251 – 2BL2341	120	31.7	7.0	1.85

### 12.3.2 Filling quantity of descaling agent

Use pure citric acid in granular form as a descaling agent. The filling quantity is designed for medium filling of the separator with mains water.

Type	[kg]	[lbs]
2BL2041	2.0	4.4
2BL2061   2BL2101	4.0	8.8
2BL2141	5.0	11
2BL2251 – 2BL2341	8.0	17.6

### 12.3.3 Filling quantity of corrosion inhibitor

Only use agent based on ethylene glycol as a corrosion inhibitor (e.g. Antifrogen from Clariant). The filling quantity is designed for the entire interior of the installed pump.

Type	[l]	[gal(US)]
2BL2041	0.6	0.16
2BL2061 – 2BL2141	1.0	0.26
2BL2251	5.5	1.45
2BL2281	6.3	1.66
2BL2341	7.0	1.85

## 12.4 Weight

Type	without operating fluid		with operating fluid	
	[kg]	[lbs]	[kg]	[lbs]
2BL2041	40	89	64	141
2BL2061	55	122	100	221
2BL2101	72	159	117	258
2BL2141	110	243	159	351
2BL2251	223	492	350	772
2BL2281	228	503	355	783
2BL2341	247	545	374	825

## 12.5 Acoustic emissions

**Emission sound pressure level  $L_{pA}$**  according to noise test code ISO 2151 with reference to the basic standard ISO 3744. Measured at a distance of 1 m for medium throttle (100 mbar abs) and connected feed lines, tolerance  $\pm 3$  dB (A).

Type	50 Hz	60 Hz
	[dB(A)]	[dB(A)]
2BL2041	65	69
2BL2061	68	73
2BL2101	73	78
2BL2141	75	78
2BL2251	71	76
2BL2281	73	78
2BL2341	72	70



[www.gd-elmorietschle.de](http://www.gd-elmorietschle.de)  
[er.de@gardnerdenver.com](mailto:er.de@gardnerdenver.com)

---

**Gardner Denver  
Deutschland GmbH**  
Industriestraße 26  
97616 Bad Neustadt · Deutschland  
Tel. +49 9771 6888-0  
Fax +49 9771 6888-4000

Elmo Rietschle is a brand of Gardner Denver

**Gardner  
Denver**

Your Ultimate Source for Vacuum and Pressure